

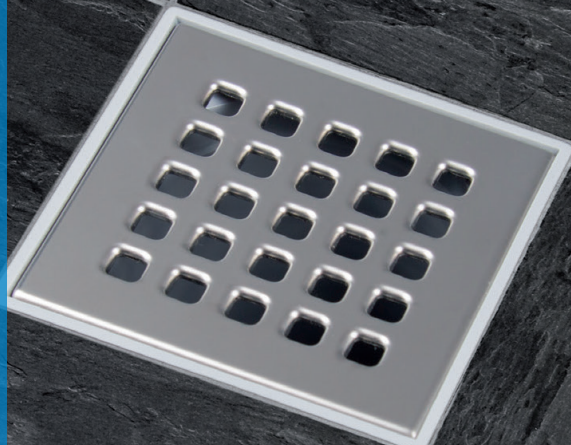

# INSTRUCCIONES DE MONTAJE

## INSTRUÇÕES DE INSTALAÇÃO



**ES**  
SUMIDERO SIFÓNICO  
EXTENSIBLE DE 120 X  
120 MM PARA PLATO  
DE DUCHA DE OBRA

**PT**  
RALO SIFÓNICO  
EXTENSÍVEL DE 120 X  
120 MM PARA BASES  
DE DUCHE

# SOPRACQUA SYSTEMS

# SUMIDERO 120 / RALO 120

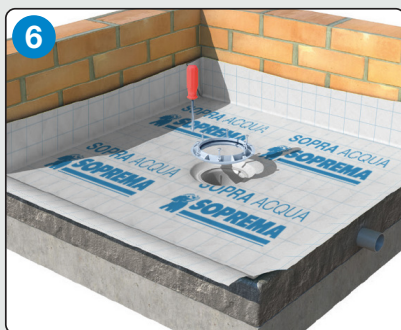
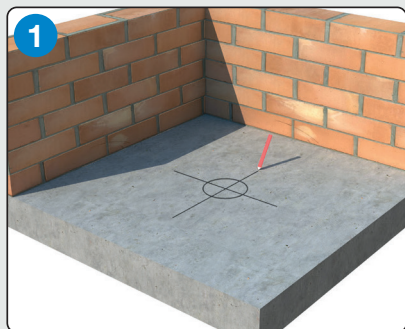

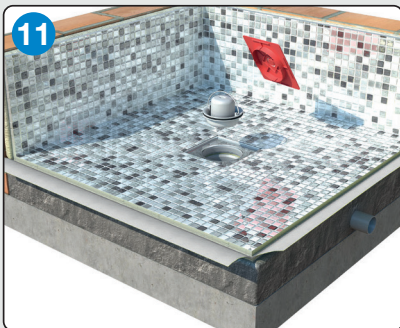
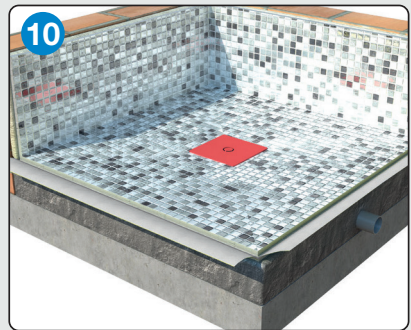
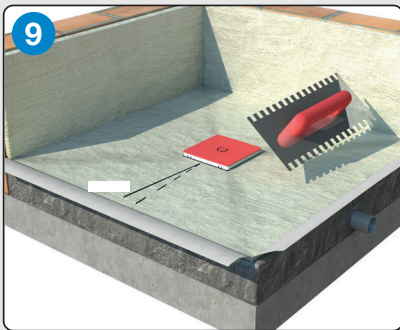
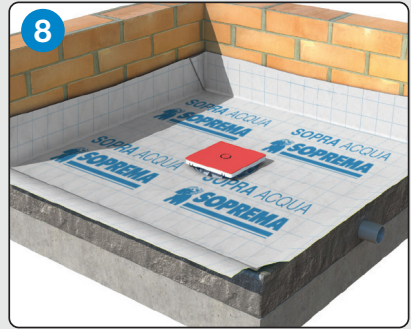
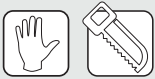

# MILES DE ACABADOS / DIVERSOS ACABAMENTOS

120 x 120 mm

Diag



Square

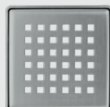

Soft

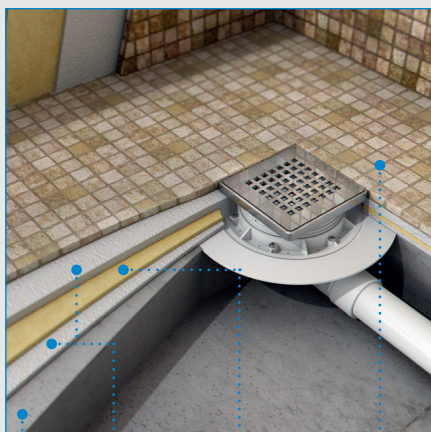
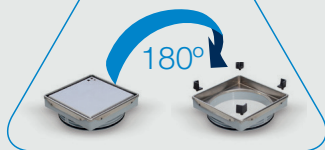

**Estructura de relleno**  
Estrutura de betão

**Cemento cola C2**  
Cimento cola C2

**Membrana impermeabilizante SOPRACQUA**  
Membrana impermeabilizante SOPRACQUA

**Azulejos**  
Revestimento cerámico

## COTAS / COTAS

**Sumidero**

Ralo

**120 mm**

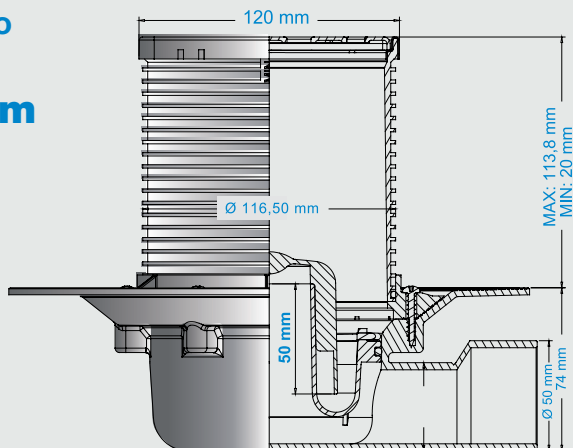

**SOPREMA IBERIA, S.L.U.**

Telf. 93 635 14 00

**SOPREMA**  
a tu servicio  
[www.soprema.es](http://www.soprema.es)  
[info@soprema.es](mailto:info@soprema.es)

